



US 20180067861A1

(19) **United States**

(12) **Patent Application Publication**

Yang et al.

(10) **Pub. No.: US 2018/0067861 A1**

(43) **Pub. Date: Mar. 8, 2018**

(54) **DUPLICATE IN-MEMORY
SHARED-INTERMEDIATE DATA
DETECTION AND REUSE MODULE IN
SPARK FRAMEWORK**

(52) **U.S. Cl.**
CPC *G06F 12/0862* (2013.01); *G06F 2212/69*
(2013.01); *G06F 2212/602* (2013.01); *G06F*
12/124 (2013.01)

(71) Applicant: **Samsung Electronics Co., Ltd.**,
Suwon-si (KR)

(57) **ABSTRACT**

(72) Inventors: **Zhengyu Yang**, Boston, MA (US);
Jiayin Wang, Dorchester, MA (US);
Thomas David Evans, San Marcos, CA
(US)

A cache management system for managing a plurality of intermediate data includes a processor, and a memory having stored thereon the plurality of intermediate data and instructions that when executed by the processor, cause the processor to perform identifying a new intermediate data to be accessed, loading the intermediate data from the memory in response to identifying the new intermediate data as one of the plurality of intermediate data, and in response to not identifying the new intermediate data as one of the plurality of intermediate data identifying a reusable intermediate data having a longest duplicate generating logic chain that is at least in part the same as a generating logic chain of the new intermediate data, and generating the new intermediate data from the reusable intermediate data and a portion of the generating logic chain of the new intermediate data not in common with the reusable intermediate data.

(21) Appl. No.: **15/404,100**

(22) Filed: **Jan. 11, 2017**

Related U.S. Application Data

(60) Provisional application No. 62/384,078, filed on Sep. 6, 2016.

Publication Classification

(51) **Int. Cl.**
G06F 12/0862 (2006.01)
G06F 12/123 (2006.01)

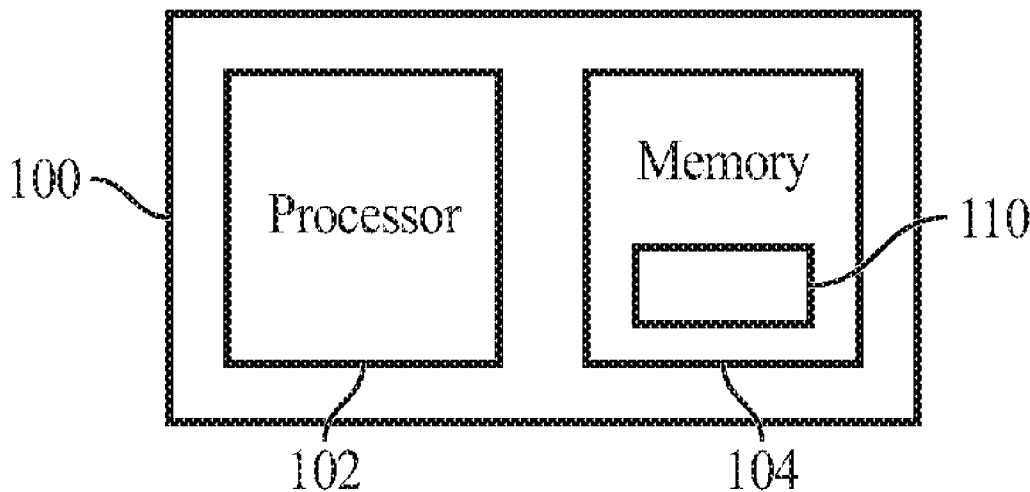

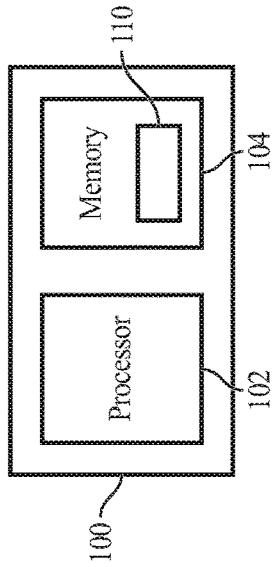

FIG. 1

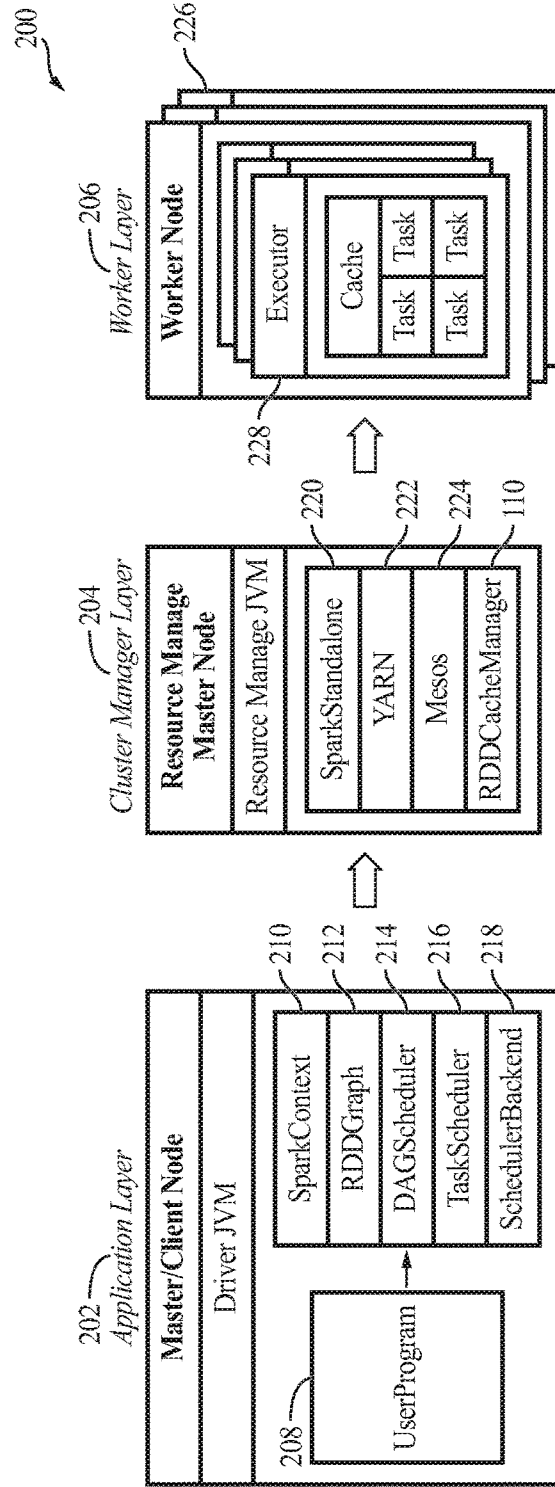

FIG. 2

300 ↗

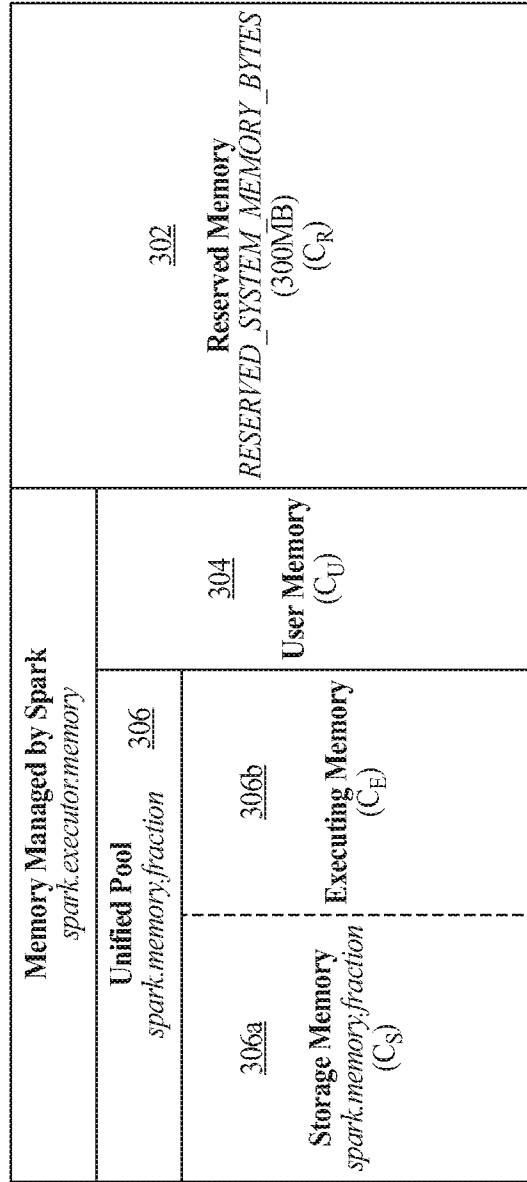

FIG. 3

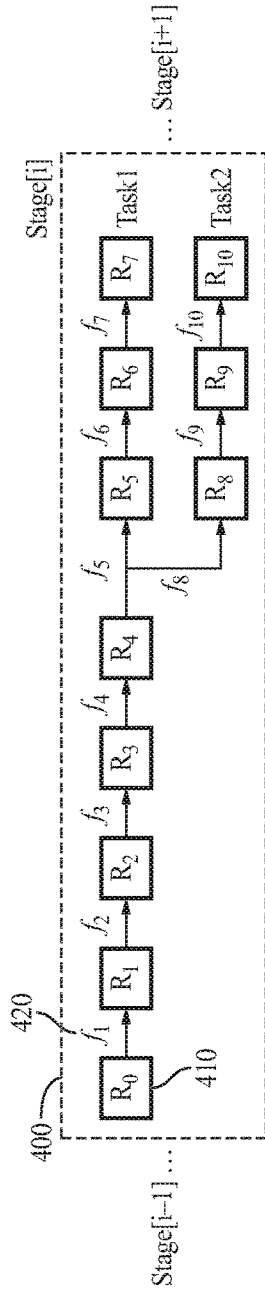

FIG. 4A

430

RDD	GenChain	Child# (N _C)	Size(R)	GenTime (T _G)
R0	R0	1	R0	0
R1	f1(R0)	1	R1	T[0→1]
R2	f2(f1(R0))	1	R2	T[1→2]
R3	f3(f2(f1(R0)))	1	R3	T[2→3]
R4	f4(f3(f2(f1(R0))))	2	R4	T[3→4]
R5	f5(f4(f3(f2(f1(R0))))))	1	R5	T[4→5]
...	
R10	f10(f9(f8(...)))	0	R10	T[9→10]

FIG. 4B

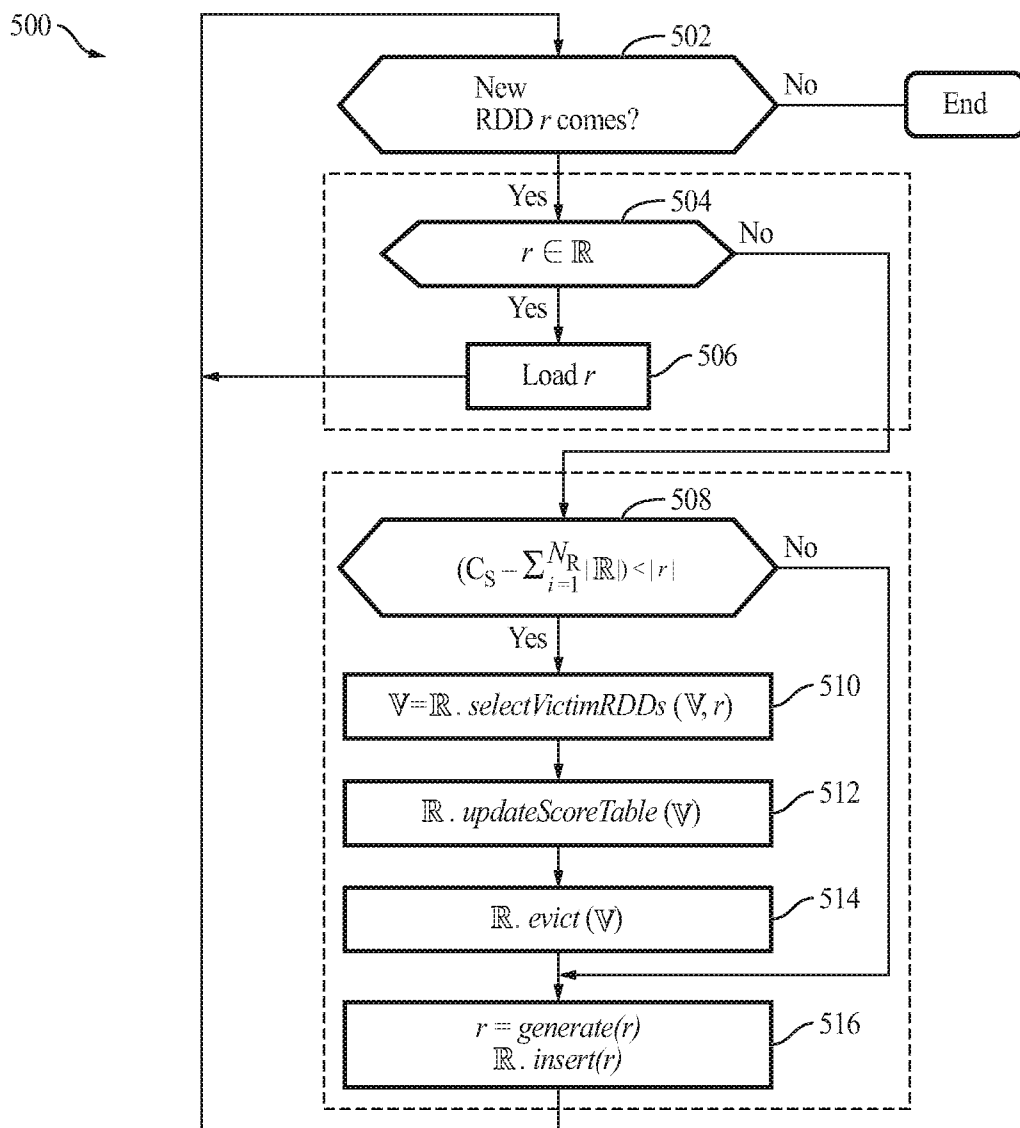

FIG. 5

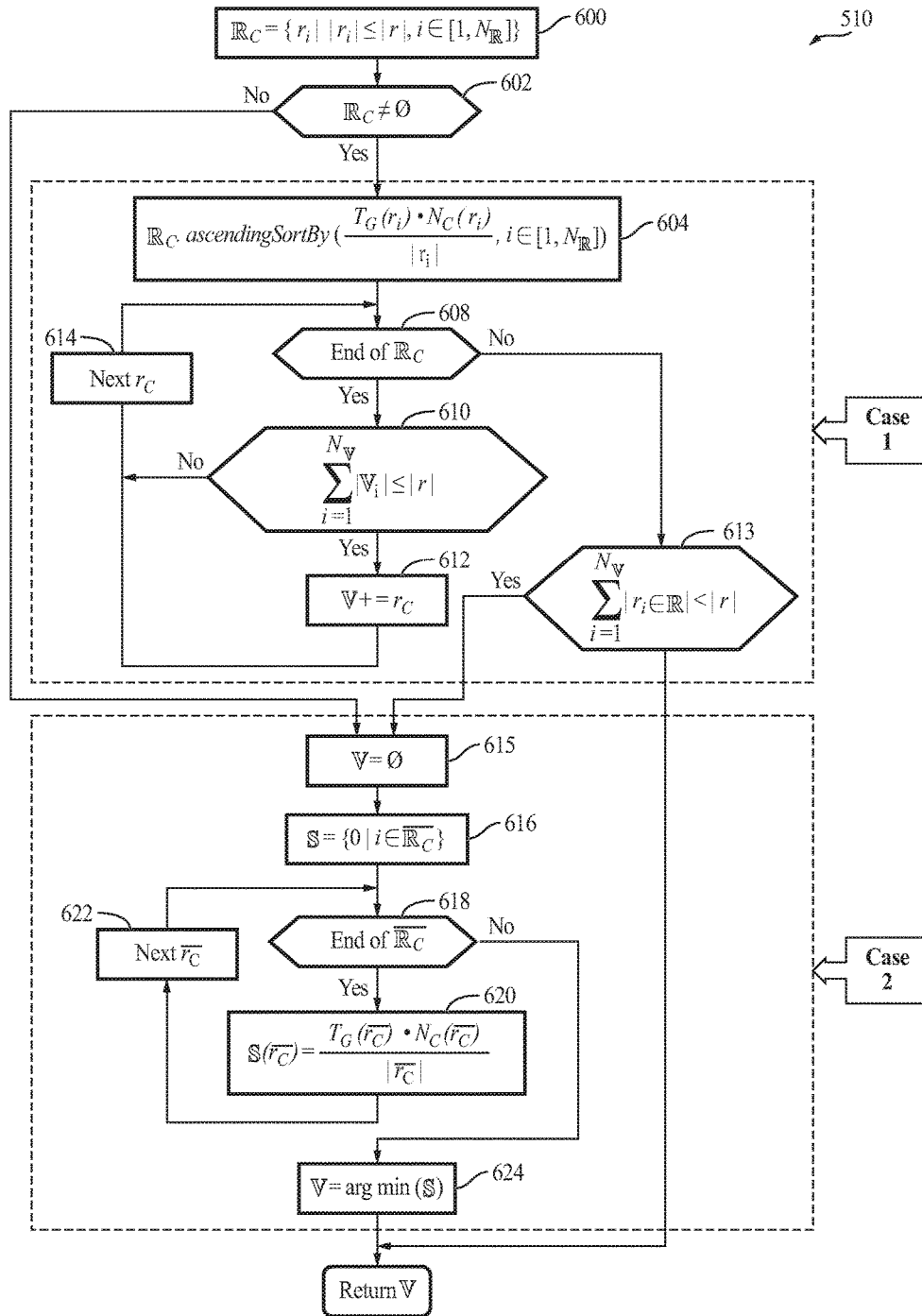

FIG. 6

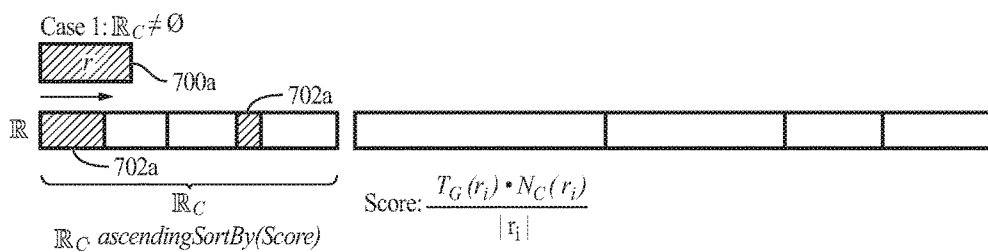

FIG. 7A

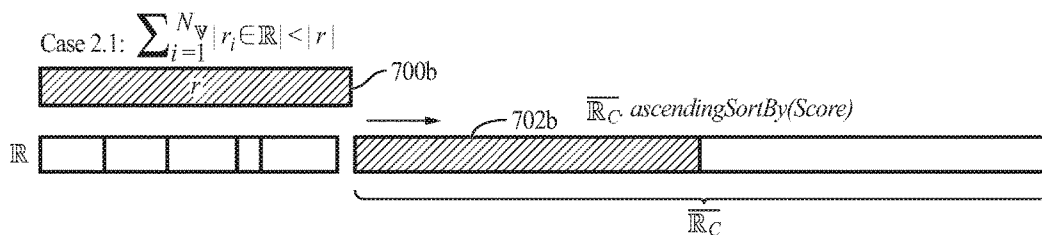

FIG. 7B

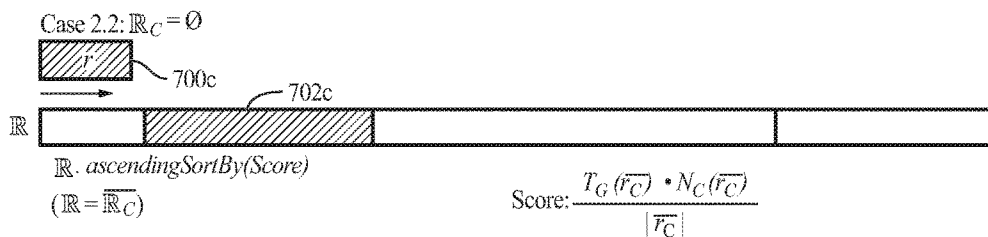

FIG. 7C

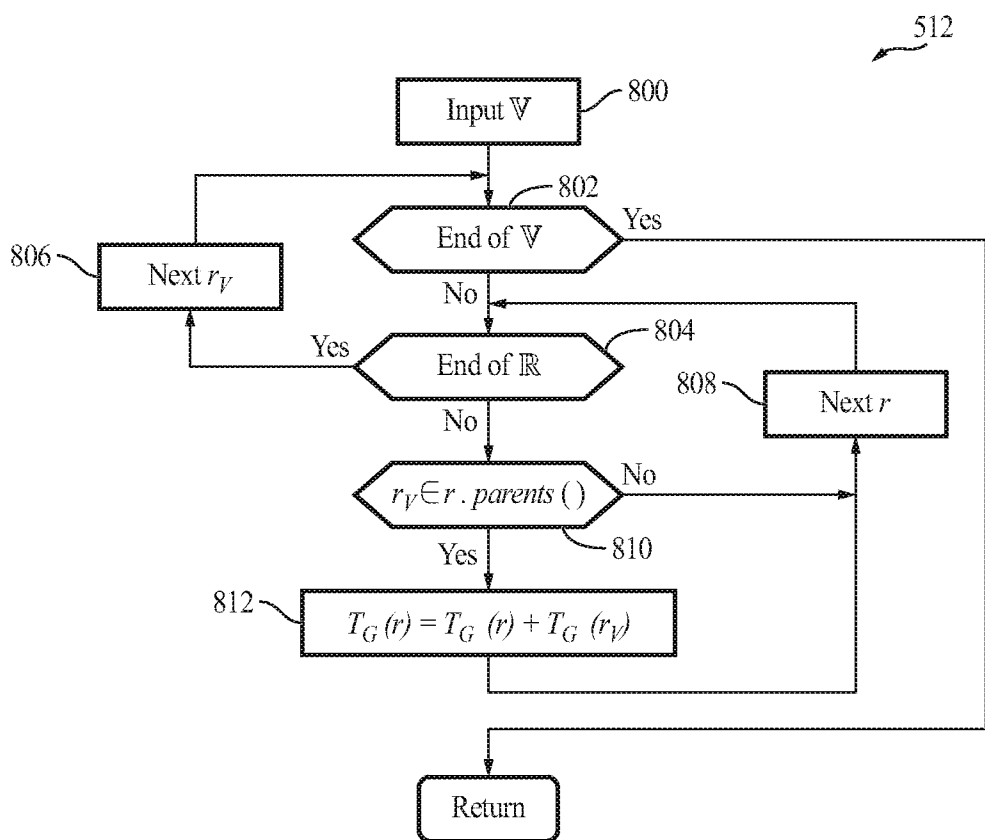

FIG. 8

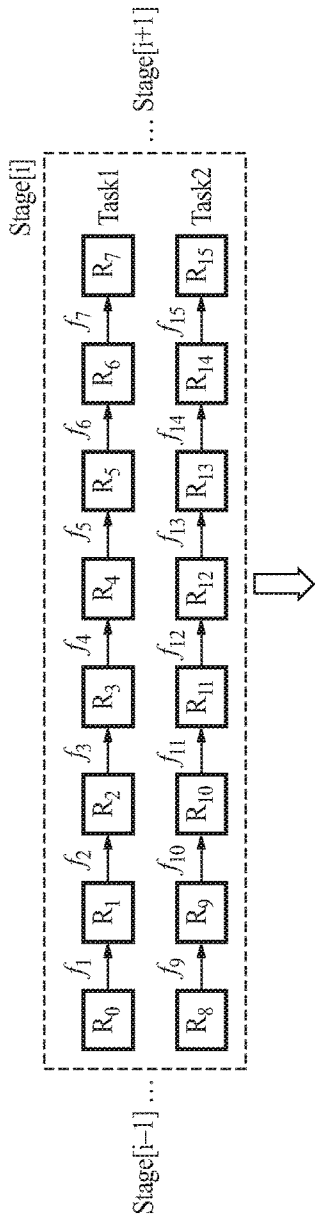

FIG. 9A

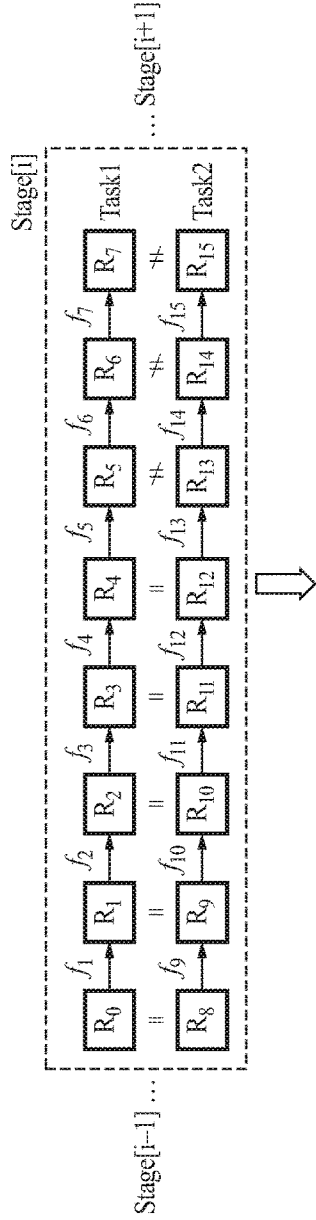

FIG. 9B

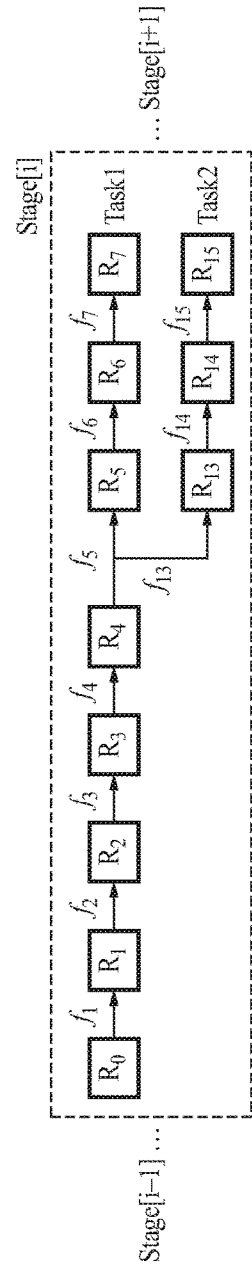

FIG. 9C

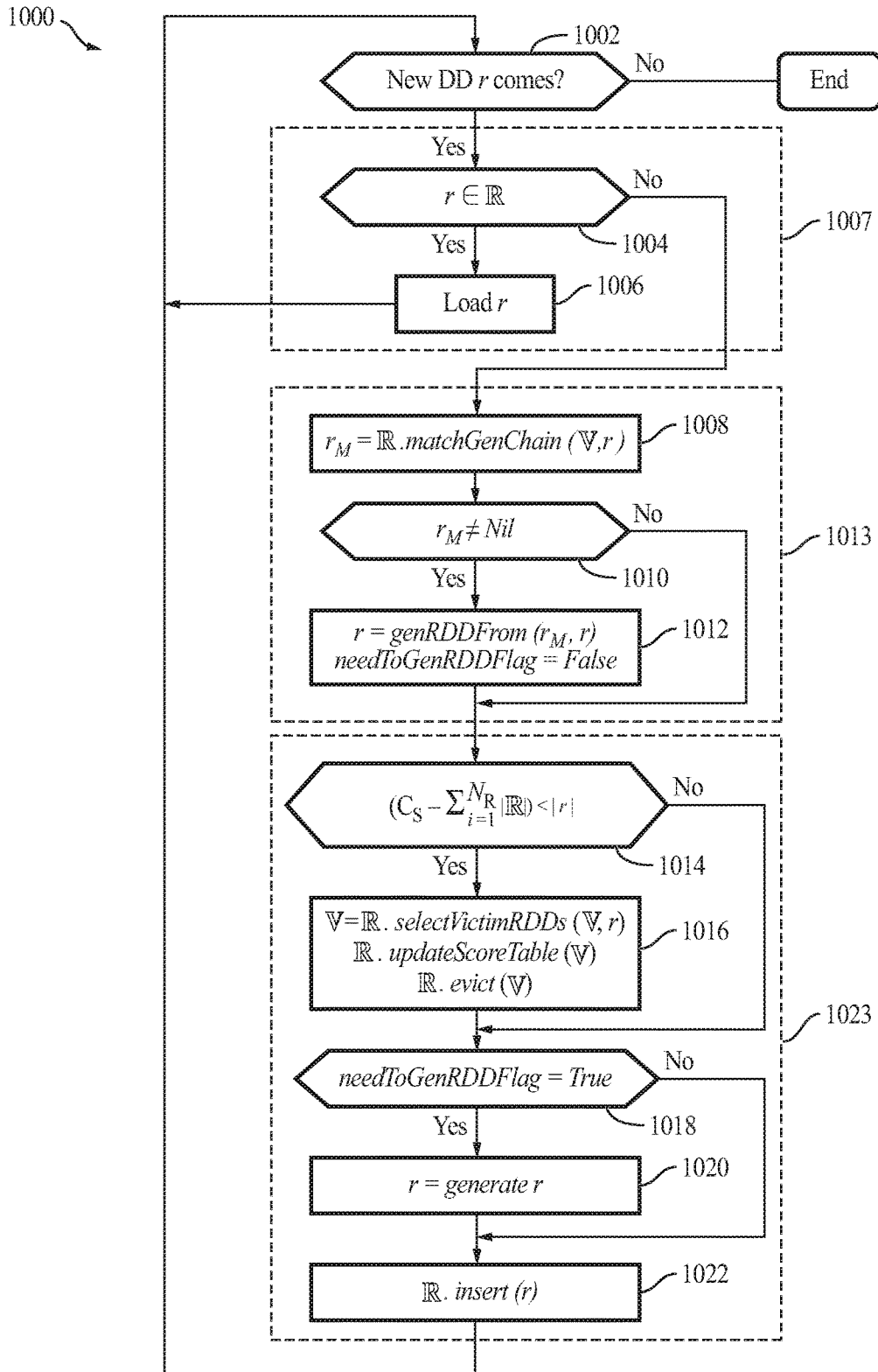

FIG. 10

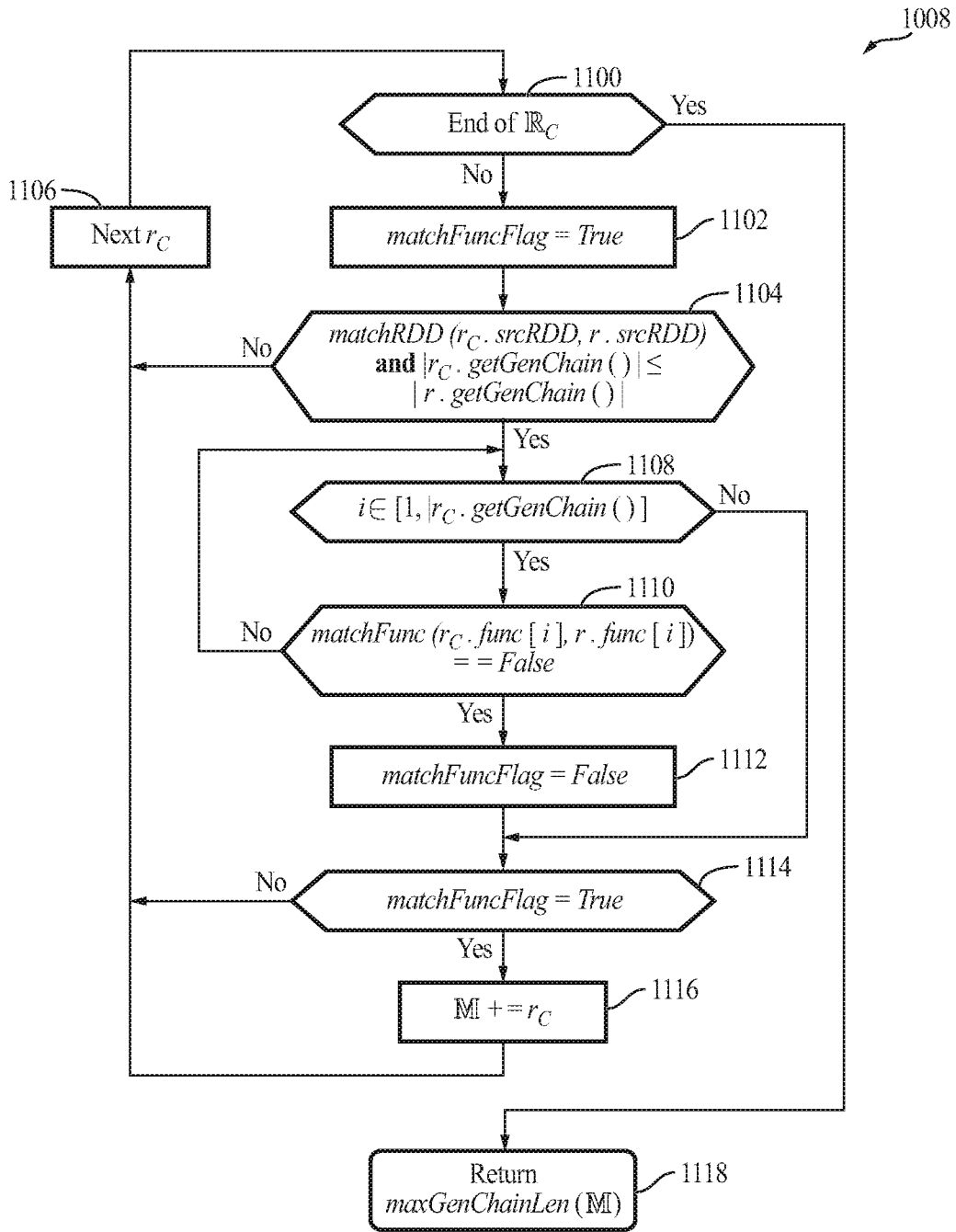

FIG. 11

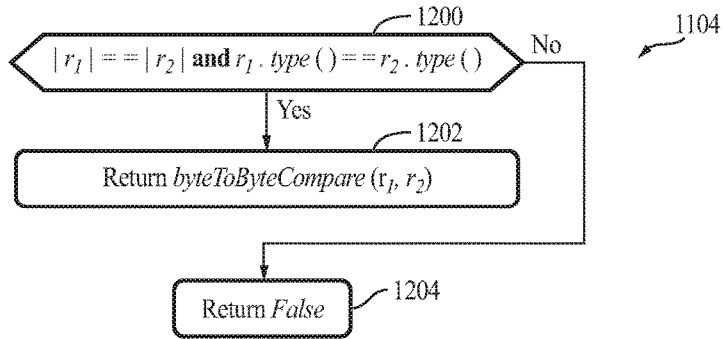

FIG. 12

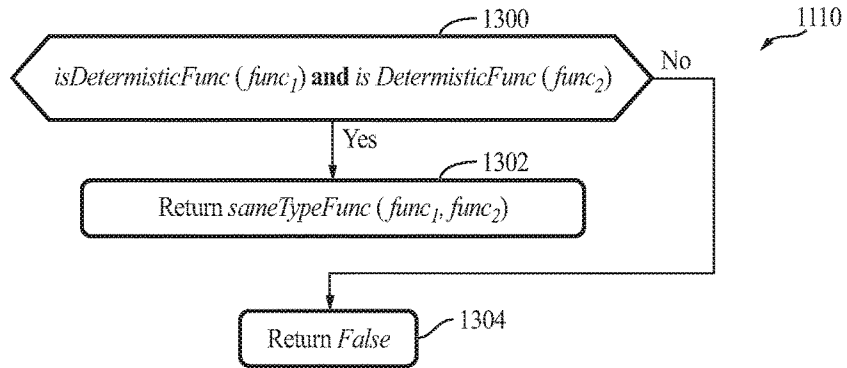

FIG. 13

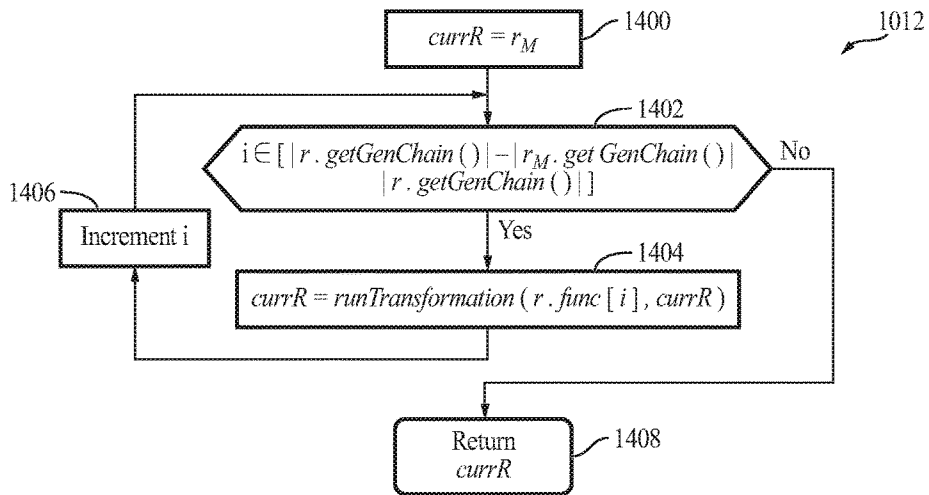

FIG. 14

**DUPLICATE IN-MEMORY
SHARED-INTERMEDIATE DATA
DETECTION AND REUSE MODULE IN
SPARK FRAMEWORK**

CROSS-REFERENCE TO RELATED
APPLICATION(S)

[0001] This application claims the benefit of and priority to U.S. Provisional Patent Application No. 62/384,078 filed Sep. 6, 2016, the entire content of which is incorporated herein by reference.

FIELD

[0002] Aspects of the present invention relate to the field of memory management in memory systems.

BACKGROUND

[0003] The Apache Spark framework is a generalized framework for distributed data processing providing functional APIs for manipulating data at scale, in-memory data caching, and reuse across computations. It applies a set of coarse-grained transformations over partitioned data and relies on a dataset's lineage to re-compute tasks in case of failures. Spark provides programmers with an application programming interface centered on a data structure called the resilient distributed dataset (RDD), a read-only multiset of data items distributed over a cluster of machines, which is maintained in a fault-tolerant way. From a caching point of view, RDD represents distributed immutable data (partitioned data and iterator) and lazily evaluated operations (transformations). RDD has the following properties: different RDDs may have different sizes (in bytes); different RDDs' re-generating times may be different; a child RDD's re-generating time may be changed if its parent RDD(s) is (are) removed from the memory; and operations on RDD have different types, such as transformations, actions, and persistence. Spark improves the system performance by storing as many intermediate results (such as resilient distributed datasets (RDDs)) into the volatile memory instead of long-term data storage (such as a hard disk drive (HDD)) as possible.

[0004] However, to some extents, the performance of this all-in-memory design depends on how the users (i.e., application developers) hardcode and explicitly tell Spark to reuse some RDDs to reduce the makespan, that is, the length of time required to process all jobs in a schedule. In fact, without RDD-reuse declarations from users, Spark has to pay both temporal (re-computing RDDs) and spatial (storing duplicated RDD) costs for duplicated RDDs and RDD operations. This kind of resource waste commonly occurs in database query (e.g., duplicated complicated SQL conditions) and some cross-application-but-same-logic scenarios.

SUMMARY

[0005] Aspects of embodiments of the present invention are directed to an intermediate data (e.g., a resilient distributed dataset, RDD) cache manager that may be plugged into a caching subsystem having knowledge of the generating chain of each intermediate data (e.g., by disassembling operations or more advanced reverse engineering techniques). Such caching subsystem may be the cluster manager subsystem of a Spark framework. According to some embodiments, the cache manager (e.g., RDD cache man-

ager) detects and reduces duplicated intermediate data (e.g., RDDs) within memory by tracking and comparing their content and the generating logic chain (i.e., operation path). Rather than following the user declared topologic path (e.g., hardcode "preserved" RDDs), some embodiments of the present invention actively refine the RDD topological graph, in order to improve system performance by reducing both temporal (e.g., re-computation time) and spatial (e.g., memory space) costs. Thus, by merging duplicated intermediate data, embodiments of the present invention, may improve performance of cache memory (e.g., increase the hit ratio in memory).

[0006] According to some embodiments of the present invention, there is provided a cache management system for managing a plurality of intermediate data, the cache management system including: a processor; and a memory having stored thereon the plurality of intermediate data and instructions that when executed by the processor, cause the processor to perform: identifying a new intermediate data to be accessed; loading the intermediate data from the memory in response to identifying the new intermediate data as one of the plurality of intermediate data; and in response to not identifying the new intermediate data as one of the plurality of intermediate data: identifying a reusable intermediate data having a longest duplicate generating logic chain that is at least in part the same as a generating logic chain of the new intermediate data; and generating the new intermediate data from the reusable intermediate data and a portion of the generating logic chain of the new intermediate data not in common with the reusable intermediate data.

[0007] In some embodiments, the instructions further cause the processor to perform: in response to a lack of sufficient space within the memory to store the new intermediate data: selecting a set of victim intermediate data from the plurality of intermediate data to evict from the memory; and evicting the set of victim intermediate data from the memory.

[0008] In some embodiments, the identifying of the reusable intermediate data includes: identifying a subset of intermediate data, each one of the subset of intermediate data having a same intermediate data source as the new intermediate data and a generating logic chain that is not longer than that of the new intermediate data; and comparing functions of the generating logic chain of each one of the subset of intermediate data to those of the new intermediate data, in a sequence, to identify the reusable intermediate data as one of the subset of intermediate data having a longest sequence of matching functions with the new intermediate data.

[0009] In some embodiments, the sequence is an order of functions from the intermediate data source to the each one of the subset of intermediate data.

[0010] In some embodiments, the intermediate data source of each of the subset of intermediate data has a same size as, and a same type as, that of the new intermediate data.

[0011] In some embodiments, the identifying of the subset of intermediate data includes: comparing, byte-to-byte, the intermediate data source of each one of the subset of intermediate data with the new intermediate data.

[0012] In some embodiments, the comparing of the functions of the generating logic chain of each one of the subset of intermediate data to those of the new intermediate data includes: determining that the functions of the generating logic chain of each one of the subset of intermediate data and

those of the new intermediate data are deterministic; and in response, determining that types of the functions of the generating logic chain of each one of the subset of intermediate data are the same as those of the new intermediate data.

[0013] In some embodiments, the determining that the functions are deterministic includes: matching each of the functions with one of a preset list of deterministic functions.

[0014] In some embodiments, the generating of the new intermediate data from the reusable intermediate data includes: successively applying, to the reusable intermediate data, functions of the generating logic chain of the new intermediate data not in common with the reusable intermediate data to generate the new intermediate data.

[0015] In some embodiments, each one of the plurality of intermediate data is a resilient distributed data (RDD), and the cache management system operates under a Spark framework.

[0016] According to some embodiments of the present invention, there is provided a method of managing a plurality of intermediate data stored in memory, the method including: identifying, by a processor, a new intermediate data to be accessed; loading, by the processor, the intermediate data from the memory in response to identifying the new intermediate data as one of the plurality of intermediate data; and in response to not identifying the new intermediate data as one of the plurality of intermediate data: identifying, by the processor, a reusable intermediate data having a longest duplicate generating logic chain that is at least in part the same as a generating logic chain of the new intermediate data; and generating, by the processor, the new intermediate data from the reusable intermediate data and a portion of the generating logic chain of the new intermediate data not in common with the reusable intermediate data.

[0017] In some embodiments, the method further includes: in response to a lack of sufficient space within the memory to store the new intermediate data: selecting, by the processor, a set of victim intermediate data from the plurality of intermediate data to evict from the memory; and evicting, by the processor, the set of victim intermediate data from the memory.

[0018] In some embodiments, the identifying of the reusable intermediate data includes: identifying, by the processor, a subset of intermediate data, each one of the subset of intermediate data having a same intermediate data source as the new intermediate data and a generating logic chain that is not longer than that of the new intermediate data; and comparing, by the processor, functions of the generating logic chain of each one of the subset of intermediate data to those of the new intermediate data, in a sequence, to identify the reusable intermediate data as one of the subset of intermediate data having a longest sequence of matching functions with the new intermediate data.

[0019] In some embodiments, the sequence is an order of functions from the intermediate data source to the each one of the subset of intermediate data.

[0020] In some embodiments, the intermediate data source of each of the subset of intermediate data has a same size as, and a same type as, that of the new intermediate data.

[0021] In some embodiments, the identifying of the subset of intermediate data includes: comparing, byte-to-byte, by the processor, the intermediate data source of each one of the subset of intermediate data with the new intermediate data.

[0022] In some embodiments, the comparing of the functions of the generating logic chain of each one of the subset

of intermediate data to those of the new intermediate data includes: determining, by the processor, that the functions of the generating logic chain of each one of the subset of intermediate data and those of the new intermediate data are deterministic; and in response, determining, by the processor, that types of the functions of the generating logic chain of each one of the subset of intermediate data are the same as those of the new intermediate data.

[0023] In some embodiments, the determining that the functions are deterministic includes: matching, by the processor, each of the functions with one of a preset list of deterministic functions.

[0024] In some embodiments, the generating of the new intermediate data from the reusable intermediate data includes: successively applying, to the reusable intermediate data, by the processor, functions of the generating logic chain of the new intermediate data not in common with the reusable intermediate data to generate the new intermediate data.

[0025] In some embodiments, each one of the plurality of intermediate data is a resilient distributed data (RDD) within a Spark framework.

BRIEF DESCRIPTION OF THE DRAWINGS

[0026] The accompanying drawings, together with the specification, illustrate example embodiments of the present invention, and, together with the description, serve to explain the principles of the present invention.

[0027] FIG. 1 illustrates a cache management system utilizing a cache manager, according to some example embodiments of the present invention.

[0028] FIG. 2 illustrates a Spark architecture that utilizes the cache manager, according to some example embodiments of the present invention.

[0029] FIG. 3 illustrates an example of memory partitions under the Spark framework.

[0030] FIGS. 4A and 4B illustrate an example of a resilient distributed dataset (RDD) lookup procedure, according to some example embodiments of the present invention.

[0031] FIG. 5 is a flow diagram illustrating a process of performing an RDD caching policy, according to some example embodiments of the present invention.

[0032] FIG. 6 illustrates a process of victim selection performed by the cache manager, according to some example embodiments of the present invention.

[0033] FIGS. 7A-7C illustrate various cases provided in FIG. 6, according to some example embodiments of the present invention.

[0034] FIG. 8 illustrates a process of updating an RDD score table as performed by the cache manager, according to some example embodiments of the present invention.

[0035] FIGS. 9A-9C illustrate the process of deduplication performed by the cache manager, according to some example embodiments of the present invention.

[0036] FIG. 10 is a flow diagram illustrating a process of performing an RDD caching policy, according to some example embodiments of the present invention.

[0037] FIG. 11 is a flow diagram illustrating a process of matching generation chains performed by the cache manager, according to some example embodiments of the present invention.

[0038] FIG. 12 is a flow diagram illustrating a process of matching RDDs performed by the cache manager, according to some example embodiments of the present invention.

[0039] FIG. 13 is a flow diagram illustrating a process of matching functions performed by the cache manager, according to some example embodiments of the present invention.

[0040] FIG. 14 is a flow diagram illustrating a process of obtaining the longest reusable chain as performed by the cache manager, according to some example embodiments of the present invention.

DETAILED DESCRIPTION

[0041] Features of the inventive concept and methods of accomplishing the same may be understood more readily by reference to the following detailed description of embodiments and the accompanying drawings. Hereinafter, example embodiments will be described in more detail with reference to the accompanying drawings, in which like reference numbers refer to like elements throughout. The present invention, however, may be embodied in various different forms, and should not be construed as being limited to only the illustrated embodiments herein. Rather, these embodiments are provided as examples so that this disclosure will be thorough and complete, and will fully convey the aspects and features of the present invention to those skilled in the art. Accordingly, processes, elements, and techniques that are not necessary to those having ordinary skill in the art for a complete understanding of the aspects and features of the present invention may not be described. Unless otherwise noted, like reference numerals denote like elements throughout the attached drawings and the written description, and thus, descriptions thereof will not be repeated. In the drawings, the relative sizes of elements, layers, and regions may be exaggerated for clarity.

[0042] As will be understood by a person of ordinary skill in the art, while some embodiments of the present invention may be described in the context of the Apache Spark system, embodiments of the present invention are not limited thereto. Rather, embodiments of the present invention, and the term “Spark” as used herein, may be applied to any suitable cluster compute engine for scalable data processing, having the same or similar characteristics described herein.

[0043] FIG. 1 illustrates a cache management system 100 utilizing the cache manager 110, according to some example embodiments of the present invention.

[0044] The processing system 100 may include a processor 102 and a memory 104. The memory 104 may include volatile memory (e.g., random access memory (RAM), such as dynamic RAM) and non-volatile memory (e.g., a hard disk drive (HDD) or a solid state drive (SSD)), which may serve as long-term storage. The cache manager 110, according to some embodiments, may reside at the memory 104 and its operations may be performed by the processor 102.

[0045] According to some embodiments, the cache manager 110 may operate within the Spark framework. Spark is a generalized framework for distributed data processing providing functional application programming interface (API) for manipulating data at scale, in-memory data caching and reuse across computations. Spark applies a set of coarse-grained transformations over partitioned data and relies on a dataset's lineage to re-compute tasks in case of failures. Spark supports a majority of data formats, has integrations with various storage systems, and may be executed on a cluster manager, such as Apache Mesos or Apache Hadoop YARN (Yet Another Resource Negotiator).

[0046] FIG. 2 illustrates an architecture (e.g., a Spark architecture) 200 that utilizes the cache manager 110 according to some example embodiments of the present invention.

[0047] Referring to FIG. 2, the spark architecture 200 includes an application layer (e.g., a Spark Application Layer) 202, a cluster manager layer 204, and a worker layer 206.

[0048] The spark application layer includes user program 208 and spark context 210 and creates RDDs and performing a series of transformations to achieve a final result. The RDD may represent a minimum unit for caching. These transformations of RDDs are then translated into a directed Acyclic graph (DAG) structure (also referred to as an RDD architecture, an RDD graph, or a generating logic chain) and submitted to the DAG scheduler 214 to be executed on a set of worker nodes 220. The spark context 210 represents the connection to a spark cluster, and may be used to create RDDs, accumulators, and broadcast variables on that cluster. For example, the spark context 210 includes RDD graph 212, DAG scheduler 214, task scheduler 216, and scheduler backend modules 218.

[0049] The cluster manager layer 204 may run different implementations (e.g., spark standalone 220, YARN 222, Mesos 224). According to some embodiments, the cache manager (e.g., of the resilient distributed dataset, RDD) 110 resides at (e.g., is configured to be incorporated or plugged into) the cluster manager layer 204.

[0050] The worker Layer 206 includes multiple work nodes 226, each of which is a java virtual machine (JVM) running multiple executors 228. The executors 228 run tasks scheduled by a driver, store computation results in memory, and then conduct on-disk or off-heap interactions with storage systems. The executors 228 may run as Java processes, so that the available memory is equal to the heap size. Internally available memory is split into several regions with specific functions.

[0051] FIG. 3 illustrates an example of memory partitions under the Spark framework.

[0052] Referring to FIG. 3, the volatile portion 300 of memory 104 may be partitioned into reserved memory 302, user memory 304, and the unified pool 306. The reserved memory (C_R) 302 is reserved by the system and has a hardcoded size (e.g., 300 MB in Spark version 1.6). This partition is for running executor 228 and may not be strictly related to Spark. The user memory (C_U) 304 may store user data structures, which may be used in RDD transformations, and internal metadata used by Spark. For example, users may rewrite Spark aggregation by using the mapPartitions transformation maintaining hash table for this aggregation to run, which would consume user memory 304. The unified pool may be split into two non-static sub-partitions: storage memory 306a and executing memory 306b, and the boundary therebetween may be set by the spark.memory.storage-Fraction parameter (defaults to 50%). The storage memory (C_S) 306a is used for storing Spark cached data and for temporary space serialized data unroll. Also, all the broadcast variables are stored there as cached blocks. The cache manager 110, according to some embodiments, is focused on this partition, as user “preserved” RDDs are stored in the storage memory 306a. The executing memory (C_E) 306b is used for storing the objects required during the execution of Spark tasks. The size of said memory partitions may be related according to the following two Equations:

$$C = C_R + C_U + C_E + C_S \quad (1)$$

$$C_S = (C - C_R - C_U) \times \epsilon \quad (2)$$

[0053] where C represents total memory size, and ϵ (i.e., spark.memory.fraction) adjusts the sizes of storage and executing memory 306a and 306b. The cache manager 110 is incorporated into the cluster manager layer 204 and operates on the RDDs stored (“preserved”) by the user in the storage memory 306a. Embodiments of the present invention primarily focus on the scenario where the amount of total (or accumulated) preserved RDDs requested by the user is larger than the total available space of storage memory (C_S), and the cache manager 110, rather than using the related art least recently used (LRU) eviction policy, intelligently and efficiently evicts RDD victims before inserting a new RDD.

[0054] According to embodiments of the present invention, the cache manager 110 performs a caching replacement process, whereby victim datasets (e.g., victim RDD(s)) are selected with the consideration of both the importance and sizes of these cached RDDs. For example, for each cache miss, the cache manager 110 may comprehensively make decisions based on a “score table” which monitors each RDD’s re-generate time cost, children/dependence number, occupancy size, and/or the like. Embodiments of the present invention may be configured to increase the caching hit ratio in memory 104 and improve the overall system performance (e.g., performance of Spark framework) by reusing intermediate data (e.g., RDDs) instead of re-computing them. According to some embodiments of the present invention, intermediate data is reused by optimizing the cache that stores user preserved intermediate data sets (e.g., user preserved RDDs).

[0055] FIGS. 4A and 4B illustrate an example of an RDD lookup procedure, according to some example embodiments of the present invention. FIG. 4A illustrates an example of a DAG structure (e.g., an RDD graph or generating logic chain) 400 of an example RDD transformation, where there are 11 RDDs (intermediate data) 410 and 10 transformations 420 in stage[i]. FIG. 4B illustrates an example score table 430 generated and maintained by the cache manager 110, according to some embodiments of the present invention, to track certain information about each accessed RDD. According to some embodiments, the cache manager 110 records, in the score table 430, spatial (i.e., RDD size in bytes) and temporal (i.e., re-computation) costs, as well as generating operation chain (i.e., GenChain, source RDD, child#) of each RDD. Based on these tabulated records, the cache manager 110 can calculate the score (e.g., “importance degree”) of each RDD when making decisions on victim selection and eviction. In some embodiments, the score table contains more parameters than those shown in Table 1, such as time costs of prefetching from memory/SSD/HDD if a multi-tier storage system is utilized. In some embodiments, the score table is stored in the storage memory 306a; however, embodiments of the present invention are not limited thereto, and the score table may be at least partially (e.g., fully) stored in non-volatile memory (e.g., NVMe disk, SSD or HDD).

[0056] FIG. 5 is a flow diagram illustrating a process 500 of the cache manager 110 for performing an RDD caching policy, according to some example embodiments of the present invention.

[0057] According to some examples, for every new RDD to be accessed (act 502), when the new RDD r is found in the cache \mathbb{R} in act 504 (i.e., there is cache hit), the cache manager 110 loads the cached RDD r in act 506. Otherwise, if the RDD r is not found in the cache \mathbb{R} in act 504, the cache manager 110 first checks, in act 508, whether the cache (i.e., storage memory (C_S) 306a) has sufficient capacity to store the new RDD. If there is sufficient space for the RDD, the cache manager 110 proceeds to act 516. If there is insufficient space for the RDD, in act 510, the cache manager 110 selects victim RDD(s) to evict (e.g., delete) from the cache (the selectVictimRDDs function); in act 512, updates the score table (the updateScoreTable function) accordingly; and, in act 514, evicts the victim RDD(s). Thereafter, in act 516, the cache manager 110 generates (e.g., computes) the new RDD r and inserts it into the memory (e.g., storage memory (C_S) 306a). The process 500 is also shown as the pseudo code below:

Process 500

```

1 Procedure RDDCache (r)
2   for each new RDD r do
3     if  $r \in \mathbb{R}$  then
4       load r
5     else
6       if  $(C_S - \sum_{i=1}^{N_{\mathbb{R}}} |\mathbb{R}|) < |r|$  then
7          $\mathbb{V} = \emptyset$ 
8          $\mathbb{V} = \mathbb{R}.\text{selectVictimRDDs}(\mathbb{V}, r)$ 
9         updateScoreTable( $\mathbb{R}, \mathbb{V}$ )
10         $\mathbb{R}.\text{evict}(\mathbb{V})$ 
11         $r = \text{generate}(r)$ 
12         $\mathbb{R}.\text{insert}(r)$ 
14 Return
```

[0058] where \mathbb{R} represents the set of RDDs stored in the storage memory 306a (e.g., RAM), \mathbb{V} represents the set of victim RDDs to be evicted from the storage memory 306a, and $N_{\mathbb{R}}$ represents the total number of RDDs in the storage memory 306a, C_S represents the size (e.g., in bytes) of the storage memory 306a, $\sum_{i=1}^{N_{\mathbb{R}}} |\mathbb{R}|$ represents the sum total of the size of the set of RDDs stored in the storage memory 306a, and $|r|$ represents the size of the new RDD.

[0059] According to some embodiments, the RDD victim selection process (i.e., the selectVictimRDDs function) is converted to a multi-objective optimization process, as expressed in equations 3 to 6 below:

$$\text{Minimize } \left(\left(\sum_{i=1}^{N_{\mathbb{V}}} |\mathbb{V}_i| \right) - |r|, \sum_{i=1}^{N_{\mathbb{V}}} S(\mathbb{V}_i) \right) \quad (3)$$

$$\text{Subject to: } |r| \leq C_S \quad (4)$$

$$\mathbb{V} \subseteq \mathbb{R} \quad (5)$$

$$\left(\sum_{i=1}^{N_{\mathbb{V}}} |\mathbb{V}_i| \right) - |r| \geq 0 \quad (6)$$

[0060] The first objective function in Equation 3 aims to reduce (e.g., minimize) the size of the evicted RDD(s) \mathbb{V} ($\sum_{i=1}^{N_{\mathbb{V}}} |\mathbb{V}_i|$), where $N_{\mathbb{V}}$ represents the number of victim RDD (s)) based on the size of the new RDD ($|r|$). The aim of the

second objective function in Equation 3 is to minimize the total of the scores of evicted RDDs ($\sum_{i=1}^{N_v} S(\mathbb{V}_i)$). The score of an RDD may represent the importance of the RDD and may be determined based on the score table 430, which tracks each accessed RDD's generating logic chain (transformation functions and dependent RDDs), children number, RDD size in bytes, and generating time cost (re-computing time). In some embodiments of the present invention, the cache manager 110 evicts as few stored RDDs as possible, and selects for eviction those RDD with as low a score as possible.

[0061] Equation 4 expresses the assumption upon which the process 500 is based, which is that the new RDD (r) should not be larger than the entire available memory size (i.e., C_S , the entire size of the memory storage 306a).

Equation 5 expresses that the set of victim RDD(s) (\mathbb{V}) is a subset of the entire RDD set (\mathbb{R}) stored in the RAM. Equation 6 expresses the aim that the total space of victims should cover the new RDD's working set space.

[0062] According to embodiments of the present invention, when selecting victim RDDs, the cache manager 110 aims to achieve the objective of Equation 3 as much as practicable, while also satisfying the conditions of Equations 4 to 6. Example embodiments of the present invention operate to set different importance score functions and victim candidate sets for different cases.

[0063] FIG. 6 illustrates the process 510 of victim selection (i.e., the selectVictimRDDs function) performed by the cache manager 110, according to some example embodiments of the present invention. The process 510 is also shown in the pseudo code below:

```

Process 510
1   Procedure selectVictimRDDs ( $\mathbb{V}, r$ )
2    $\mathbb{R}_C = \{r_i \mid |r_i| \leq |r|, i \in [1, N_R]\}$ 
3   if  $\mathbb{R}_C \neq \emptyset$  do
4
5        $\mathbb{R}_C$ .ascendingSortBy( $\frac{T_G(r_i) \cdot N_C(r_i)}{|r_i|}, i \in [1, N_R]$ )
6
7       for  $r_C$  in  $\mathbb{R}_C$  do
8           if  $\sum_{i=1}^{N_v} |V_i| \leq |r|$  then
9                $\mathbb{V} += r_C$ 
10          else if  $\mathbb{R}_C = \emptyset$  or  $\sum_{i=1}^{N_v} |r_i$  in  $\mathbb{R}_C| < |r|$  then
11               $\mathbb{S} = \{0 \mid i \in \mathbb{R}_C\}$ 
12              for  $\bar{r}_C \in \mathbb{R}_C$  do
13                   $\mathbb{S}(\bar{r}_C) = \frac{T_G(\bar{r}_C) \cdot N_C(\bar{r}_C)}{|\bar{r}_C|}$ 
14               $\mathbb{V} = \text{argmin}(\mathbb{S})$ 
15              return  $\mathbb{V}$ 

```

[0064] where \mathbb{R}_C represents the set of cached (stored) RDDs (a first set of intermediate data) whose sizes are less than or equal to the new RDD (r), and \mathbb{S} represents the record of scores of all RDDs stored in the memory (e.g., storage memory 306a).

[0065] In act 600, a subset of cached RDDs (\mathbb{R}_C) to record all RDDs whose sizes are smaller than the new RDD (r) is maintained. In act 602, based on whether \mathbb{R}_C is an empty set or not, the problem is categorized into two cases:

[0066] Case 1: If \mathbb{R}_C is not an empty set, in act 604, the cache manager 110 sets those cached RDDs whose sizes are smaller than r as victim candidates. To select one or more victims from \mathbb{R}_C , the cache manager 110 defines a first score (e.g., an importance degree score) as:

$$\text{Score-v1: } \frac{T_G(i) \cdot N_C(i)}{|R_i|}, \quad (7)$$

where $T_G(i)$, $N_C(i)$ and $|R_i|$ represent the re-computing (generation) time cost, the number of children RDDs, and the size (in bytes) of RDD i , respectively. As expressed in Equation 7, the cache manager 110 may assign a higher score (a higher importance degree) to an RDD that has a higher re-computing time $T_G(i)$, a greater number of children, and/or a smaller size, as the eviction of such RDDs may have a higher impact on the remaining RDDs and/or consume more system resources to recreate.

[0067] In act 608, the cache manager 110 sorts the victim candidates based on (e.g., in ascending or descending order of) the first score (Score-v1). In acts 608-614, the cache manager 110 adds the sorted RDDs to the victim RDDs subset \mathbb{V} until the size of \mathbb{V} is equal to or greater than the new RDD r .

[0068] Case 2: This may be presented as two sub-cases: in the first sub-case, \mathbb{R}_C is not empty, but even if all RDDs in \mathbb{R}_C are selected as victim RDDs, there is still not enough space for the new RDD r (i.e., $\sum_{i=1}^{N_v} |r_i$ in $\mathbb{R}_C| > |r|$; act 613).

In the second sub-case, \mathbb{R}_C is empty, indicating that the new RDD r is smaller than all cached RDDs, in which case the cache manager 110 selects just one RDD to evict.

[0069] In either sub-case, the cache manager 110 empties, in act 615, the victim RDD set \mathbb{V} and selects and adds, in acts 616-622, only one RDD from \mathbb{R}_C ($\mathbb{R}_C = \mathbb{R} - \mathbb{R}_C$), the complementary set of \mathbb{R}_C (the second set of intermediate data), to \mathbb{V} . In the second sub-case, as \mathbb{R}_C is empty, $\mathbb{R}_C = \mathbb{R}$. In either sub-case, the cache manager 110 may not simply select the smallest RDD in \mathbb{R}_C , as it may have a high importance degree. Therefore, in some embodiments, the cache manager 110 computes the scores (second scores) of the RDD in \mathbb{R}_C and selects the RDD with the least score (e.g., the least importance) as the victim \mathbb{V} (act 624). In some embodiments, the cache manager 110 defines the score of each RDD in \mathbb{R}_C using Equation 7.

[0070] As will be understood by a person of ordinary skill in the art, the first and second sub-cases may be collapsed into the second sub-case as an empty \mathbb{R}_C has a size that is less than that of the new RDD r , however, these two sub-cases are separately discussed here for clarity of illustration.

[0071] FIG. 7A illustrates case 1 described above, in which \mathbb{R}_C is not empty. FIGS. 7B and 7C respectively illustrate the first sub-case and the second sub-case of Case 2 described above. In FIGS. 7A to 7C, cell 700a/b/c indicates the new RDD r and cell(s) 702a/b/c indicates the victim RDD(s) selected for eviction.

[0072] According to some embodiments, after the victim RDD set \mathbb{V} is determined, and before the constituent RDD (s) is/are evicted from the storage memory 306a (e.g., the cache \mathbb{R}), the cache manager 110 updates the score table.

The reason for this is that once an RDD is evicted, the re-computing time cost of all other RDDs that are related to said RDD (i.e., “children” of said RDD) will be changed. For example, if $RDD_3=f_3(RDD_2)$, and if the parent, RDD_2 , is cached in the memory, then R_3 's time cost is $T[R2 \rightarrow R3]$. However, if RDD_2 is selected as a victim RDD to be removed, the cache manager **110** calculates RDD_3 from RDD_1 if $RDD_2=f_2(RDD_1)$, and thus, the cache manager **110** updates the time cost of RDD_3 as $T[R1 \rightarrow R2]+T[R2 \rightarrow R3]$. [0073] FIG. 8 illustrates the process **512** of updating the score table **430** (i.e., the updateScoreTable function) performed by the cache manager **110**, according to some example embodiments of the present invention. The process **512** is also shown in the pseudo code below:

```

Process 512
-----
1  Procedure updateScoreTable (R, V)
2  for  $r_p$  in V do
3  for  $r$  in R do
4  if  $r_p \in r.parents()$  then
5   $T_G(r) = T_G(r) + T_G(r_p)$ 
6  return
-----

```

Note:

parent(): Get the set of a certain RDD's parents.

[0074] In acts **800-812**, for each selected victim RDD r_v in the victim subset V , the cache manager **110** updates re-computing times of those existing RDDs in R that depend on said r_p . In act **810**, the cache manager **110** identifies a parent (e.g., a direct parent) of the victim RDD r_p , and in act **812**, increments the re-compute time of the parent RDD by the re-compute time of the victim RDD r_p , and updates the score table **430** accordingly. In some embodiments, the cache manager **110** identifies a parent (e.g., direct parent) of an RDD based on the generating logic chain recorded in the score table **430** (see, e.g., FIG. 4B). In other words, the cache manager **110** identifies a child of each of the selected victim RDD r_v in the victim subset V , and re-computes the generation (re-compute) time based on the generation time of the respective victim RDD r_p .

[0075] According to embodiments of the present invention, the cache manager **110** performs deduplication of intermediate data (e.g., RDDs) by detecting and reducing duplicated intermediate data (e.g., duplicate RDDs) by tracking and comparing their content and the generating logic chain (i.e., operation path). Instead of solely following the user declared topologic path (e.g., hardcoded “preserved” RDDs), the cache manager **110** further actively refines the intermediate data graph (a directed multigraph with properties attached to each vertex and edge, e.g., an RDD graph), in order to improve performance by saving both temporal (e.g., re-computation time) and spatial (e.g., memory space) costs. According to some embodiments of the present invention, the cache manager **110** is configured to be plugged into any caching subsystem that has knowledge of the generating chain of each dataset (even by disassembling operations or more advanced reverse engi-

neering techniques). Additionally, the cache manager **110** according to some example embodiments of the present invention is configured to be integrated with (e.g., adopted into) existing techniques (e.g., the techniques described in “Analyzing Compute vs. Storage Tradeoff for Video-aware Storage Efficiency” by Kathpal et al., HotStorage (2012); and “The Constrained Ski-Rental Problem and its Application to Online Cloud Cost Optimization” by Khanafer et al., INFOCOM, 2013 Proceedings IEEE (2013), the entire contents of which are incorporated herein by reference). Thus, the cache manager **110** is configured to merge duplicated datasets and increase the hit ratio in memory. The hit ratio, which is a measurement of cache memory performance, may be defined as the ratio of the number of times data requested by CPU are found in the cache (number of “hits”) to the number of total CPU data requests (which includes requests for data that are not found in the cache memory, i.e., “misses”).

[0076] According to some example embodiments of the present invention, the cache manager **110** is configured to detect duplicated RDDs and deterministic RDD operations, to reduce or avoid re-computation and duplicated RDD storage. While related-art deduplication algorithms may primarily focus on the dataset content itself, embodiments of the present invention also consider the generating chain of each dataset. Therefore, utilizing a “two-dimensional comparison” (i.e., RDDs and operations) according to embodiments of the present invention efficiently improves the dataset (e.g., RDD) reusability.

[0077] According to some embodiments of the present invention, the cache manager **110** differentiates between deterministic and non-deterministic operations and automatically tracks changes of the stored RDDs and their generating chains (e.g., time cost of re-computing if a cached RDD's parent RDD is evicted).

[0078] FIGS. 9A-9C illustrate the process of deduplication performed by the cache manager **110**, according to some example embodiments of the present invention.

[0079] In the example shown in FIG. 9A, the RDD DAG structure includes two tasks and each task has 8 RDDs in stage[i]. The illustrated RDD graph may be based on what the user (e.g., the human programmer) hardcoded. FIGS. 9B-9C illustrate the process of comparing the RDDs and operations between RDD tasks according to some example embodiments. As shown in FIG. 9B, the cache manager **110** first compares the RDDs and the operations of stage [i] from the source (i.e., left hand side) to the end (i.e., right hand side). For example, the cache manager **110** identifies RDDs R_0 to R_4 as being respectively identical to RDDs R_8 to R_{12} , and the functions f_1 to f_4 as being respectively identical to functions f_9 to f_{12} . FIG. 9C illustrates the refined RDD graph after detection and deduplication (e.g., reuse). Instead of 16 RDDs, only 11 RDDs need to be stored in the memory without any loss in terms of cache hit ratio.

[0080] Table 1 and Table 2 illustrate the score tables respectively before and after the detection and reuse process.

TABLE 1

RDD	GenChain	SrcRDD	Child# (N_c)	Size (R)	GenTime (TG)
R0	—	R0	1	R0	0
R1	f1	R0	1	R1	$T[0 \rightarrow 1]$

TABLE 1-continued

RDD	GenChain	SrcRDD	Child# (N_C)	Size (R)	GenTime (TG)
R2	f2-f1	R0	1	R2	T[1→2]
R3	f3-f2-f1	R0	1	R3	T[2→3]
R4	f4-f3-f2-f1	R0	1	R4	T[3→4]
R5	f5-f4-f3-f2-f1	R0	1	R5	T[4→5]
R6	f6-f5-f4-f3-f2-f1	R0	1	R6	T[5→6]
R7	f7-f6-f5-f4-f3-f2-f1	R0	0	R7	T[6→7]
R8	—	R8	1	R8	0
R9	f9	R8	1	R9	T[8→9]
R10	f10-f9	R8	1	R10	T[9→10]
R11	f11-f10-f9	R8	1	R11	T[10→11]
R12	f12-f11-f10-f9	R8	1	R12	T[11→12]
R13	f13-f12-f11-f10-f9	R8	1	R13	T[12→13]
R14	f14-f13-f12-f11-f10-f9	R8	1	R14	T[13→14]
R15	f15-f14-f13-f12-f11-f10-f9	R8	0	R15	T[14→15]

TABLE 2

RDD	GenChain	SrcRDD	Child# (N_C)	Size (R)	GenTime (TG)
R0	—	R0	1	R0	0
R1	f1	R0	1	R1	T[0→1]
R2	f2-f1	R0	1	R2	T[1→2]
R3	f3-f2-f1	R0	1	R3	T[2→3]
R4	f4-f3-f2-f1	R0	2	R4	T[3→4]
R5	f5-f4-f3-f2-f1	R0	1	R5	T[4→5]
R6	f6-f5-f4-f3-f2-f1	R0	1	R6	T[5→6]
R7	f7-f6-f5-f4-f3-f2-f1	R0	0	R7	T[6→7]
R13	f13-f4-f3-f2-f1	R0	1	R13	T[4→13]
R14	f14-f13-f4-f3-f2-f1	R0	1	R14	T[13→14]
R15	f15-f14-f13-f4-f3-f2-f1	R0	0	R15	T[14→15]

[0081] FIG. 10 is a flow diagram illustrating a process 1000 of the cache manager 110 for performing an RDD caching policy, according to some example embodiments of the present invention.

[0082] Process 100 illustrates an example process of the RDD caching policy inside the cluster manager subsystem 204 within which the cache manager 110 is plugged in, according to some example embodiments. In some examples, for every new RDD to be accessed (act 1002), when the new RDD r is found in the cache $\mathbf{R}0$ in act 1004 (i.e., there is cache hit), the cache manager 110 loads the cached RDD r in act 1006. Otherwise, if the RDD r is not found in the cache \mathbf{R} in act 1004, the cache manager 110 finds any matched duplicate RDDs r_M sharing all or a part of the new RDD's generation chain (GenChain in Table 1) in act 1008 (the matchGenChain function). In act 1010, if the search returns a non-nil value, r_M represents the longest RDD chains that may be reused (e.g., in the example of FIGS. 9A-9C, if the new RDD is R_{15} , then R_4 may be returned as r_M). In act 1012, the cache manager 110 then generates the remaining chain from the detected reusable RDD r_M (e.g., in the example of FIGS. 9A-9C, the cache manager 110 generates R_{13} , R_{14} , and then R_{15}). Otherwise, if the search returns a nil value in act 1010, the cache manager 110 checks, in act 1014, whether the cache (e.g., the storage memory 306a) has sufficient size (space) for this new RDD ($(C - \sum_{i=1}^{N_R} |\mathbf{R}|) < |r|$). If there is insufficient space, the cache manager 110 then selects one or more victim RDDs to evict from the cache, in act 1016. The cache manager 110 then generates (computes) the new RDD r if necessary (i.e., needToGenRDDFlag is False, in act 1018)

and inserts it into the memory, in acts 1020 and 1022. Acts 1004 and 1006 together represent a cache hit (act 1007), acts 1008 to 1012 together represent a cache deduplication process 1013, and acts 1014 to 1022 represent a cache miss (act 1023).

[0083] As acts 1014 to 1022 are substantially similar to acts 508 to 516 of FIG. 5, a detailed description thereof may not be repeated. The process 1000 is also shown as the pseudo code below:

```

Process 1000
1 Procedure RDDCache (r)
2   for each new RDD r do
3     needToGenRDDFlag = True
4     if r ∈ R then
5       load r
6     else
7       r_M = R.matchGenChain(r)
8       if r_M ≠ Nil then
9         r = genRDDFrom(r_M,r)
10        needToGenRDDFlag = False
11      if (C_S - ∑_{i=1}^{N_R} |R|) < |r| then
12        V = ∅
13        V = R.selectVictimRDDs(V,r)
14        updateScoreTable(∑_{i=1}^{N_R}, V)
15        R.evict(V)
16        if needToGenRDDFlag = True then
17          r = generate(r)
18        R.insert(r)
19  return

```

[0084] FIG. 11 is a flow diagram illustrating the process 1008 of matching generation chains (i.e., the matchGenChain function) performed by the cache manager 110, according to some example embodiments of the present invention.

[0085] Process 1008 (the matchGenChain function) implements what may be called the RDD detection policy. The cache manager 110 may operate to detect those RDDs and corresponding operations that users are not explicitly declaring in their application. To this end, the cache manager 110 first searches each stored RDD from inside to outside (e.g., left to right or “source to destination” in FIG. 9A/9B/9C) of their generating chain (source RDD, to each functions). According to some embodiments, the cache manager 110 identifies (finds) the longest reusable chain and reuses that as a detected chain. The process 1008 is also shown in pseudo code below:

Process 1008

```

1 Procedure matchGenChain( r )
2   for each candidate RDD rC do
3     matchFuncFlag = True
4     If matchRDD(rC.srcRDD,r.srcRDD) and |rC.getGenChain( )| ≤
5     |r.getGenChain( )| then
6       for i ∈ [1, |rC.getGenChain( )|] do /* from inside to outside */
7         if matchFunc(rC.func[i],r.func[i]) == False then
8           matchFuncFlag = False
9           break
10          if matchFuncFlag = True then
11            M += rC
11 return maxGenChainLen(M)

```

[0086] where M represents a set of victim RDDs to be evicted from the storage memory 306a.

[0087] In acts 1100 to 1106, the cache manager 110 checks whether the iterated RDD r_C has the same source RDD as the requested new RDD r . The cache manager 110 further ensures that candidate cached RDD r_C is not longer than the new RDD r , because the cache manager 110 aims to reuse cached RDD(s) as part of the new RDD r . In acts 1108 to 1112, the cache manager 110 iterates the comparison process following a from-inside-to-outside-of-functions order to check whether each operation (i.e., function) of the current RDD matches the corresponding function of the new RDD r . For example, if $r_C = f_4(f_3(f_2(f_1(f_0(r_0))))))$, then the cache manager 110 checks r_0 , f_0 , f_1 , f_2 , f_3 , and f_4 of r_C against the generating logic chain of the new RDD r . Only when all the iterated functions of a cached RDD match the new RDD's functions, the cache manager 110 adds the current iterated cached RDD into the candidate set M , in acts 1114 and 1116. Finally, in acts 1118, the cache manager 110 returns the longest RDD GenChain that may be reused by the new RDD r from the candidate set M (via the maxGenChainLen function). In other words, the cache manager 110 identifies a subset of intermediate data, each one of the subset of intermediate data having a same intermediate data source as the new intermediate data and a generating logic chain that is not longer than that of the new intermediate data. The cache manager 110 further compares functions of the generating logic chain of each one of the subset of intermediate data to those of the new intermediate data, in a sequence, to identify the reusable intermediate data as one of the subset of intermediate data having a longest sequence of matching functions with the new intermediate data.

[0088] According to some embodiments, the process 1008 described above may be further improved (e.g., optimized or sped up) by using some advanced data structure to record the detected duplicated RDDs and corresponding generating chains (such as a mapping table with assign functions of both RDD and functions) and adding them into the score table (e.g., Table 2). For example, if RDD_1 and RDD_2 are

detected as identical, then embodiments of the present invention record both RDD_1 and RDD_2 in one row together (in the RDD column) with their GenChains (in the GenChain column), which mean the row will be [R_1 , R_2 ; R_1 's GenChain, R_2 's GenChain; . . .]. Additionally, performance may be improved by further analyzing and making decisions on whether to store the RDD in the memory (e.g., the storage memory 306a) or not (i.e., re-compute next time), and advanced techniques to achieve that goal may be based on any suitable method known in the art (e.g., Kathpal et al., "Analyzing Compute vs. Storage Tradeoff for Video-aware Storage Efficiency," HotStorage (2012); and Khanafer et al., "The Constrained Ski-Rental Problem and its Application to Online Cloud Cost Optimization," INFOCOM, 2013 Proceedings IEEE. IEEE (2013), the entire contents of which are incorporated herein by reference).

[0089] FIG. 12 is a flow diagram illustrating the process 1104 of matching RDDs (i.e., the matchRDD function) performed by the cache manager 110, according to some example embodiments of the present invention.

[0090] According to some embodiments, the cache manager 110 first checks, in act 1200, whether the two input RDDs have the same size and the same type (in terms of data structures, objects, etc.; act 1200). If the stated conditions are satisfied, the cache manager 110 uses a byte-to-byte comparison (the byteToByteCompare function; act 1202) to further detect whether the two input RDDs are identical. However, embodiments of the present invention are not limited a byte-to-byte comparison, and any suitable comparison may be utilized. The process 1104 is also shown in pseudo code below:

Process 1104

```

1 Procedure matchRDD( r1, r2 )
2   if |r1| == |r2| and r1.type( ) == r2.type( ) then
3     return byteToByteCompare(r1, r2)
4   else
5     return False

```

[0091] In Spark, operations (i.e., functions) can be categorized into transformations, actions and other categories. Table 3 lists some example RDD transformations and actions available in Spark, where a signature of each operation is chosen to match other APIs in Scala and other functional languages, and type parameters are shown in square brackets (Seq[T] denotes a sequence of elements of type T). A difference between transformations and actions is that the former are lazy operations that define a new RDD, while the latter launch a computation to return a value to the program or write data to external storage.

TABLE 3

Categories	Functions	Details
Transformations	map(f: T ⇒ U)	RDD[T] ⇒ RDD[U]
	filter(f: T ⇒ Bool)	RDD[T] ⇒ RDD[T]
	flatMap(f: T ⇒ Seq[U])	RDD[T] ⇒ RDD[U]
	sample(fraction: Float)	RDD[T] ⇒ RDD[T] (Deterministic sampling)
	groupByKey()	RDD[(K, V)] ⇒ RDD[(K, Seq[V])]
	reduceByKey(f: (V, V) ⇒ V)	RDD[(K, V)] ⇒ RDD[(K, V)]
	union()	(RDD[T], RDD[T]) ⇒ RDD[T]
	join()	(RDD[(K, V)], RDD[(K, W)]) ⇒ RDD[(K, (V, W))]

TABLE 3-continued

Categories	Functions	Details
Actions	cogroup()	(RDD[(K, V)], RDD[(K, W)]) ⇒ RDD[(K, (Seq[V], Seq[W]))]
	crossProduct()	(RDD[T], RDD[U]) ⇒ RDD[(T, U)]
	mapValues(f: V ⇒ W)	RDD[(K, V)] ⇒ RDD[(K, W)] (Preserves partitioning)
	sort(c: Comparator[K])	RDD[(K, V)] ⇒ RDD[(K, V)]
	partitionBy(p: Partitioner[K])	RDD[(K, V)] ⇒ RDD[(K, V)]
	count()	RDD[T] ⇒ Long
	collect()	RDD[T] ⇒ Seq[T]
	reduce(f: (T, T) ⇒ T)	RDD[T] ⇒ T
	lookup(k, K)	RDD[(K, V)] ⇒ Seq[V] (On hash/range partitioned RDDs)
	save(path: String)	Outputs RDD to a storage system, e.g., HDFS

[0092] According to some embodiments of the present invention, the cache manager 110 detects those identical functions that result in exactly the same output when supplied with the same input, while these functions are not explicitly hardcoded by the users. Identical functions may be uniquely determined according to the type (signature) and input RDD(s) (act 1200). For example, in FIG. 9A, $R_o=R_s$, $f_1()=f_2()$, etc. Accordingly, the cache manager 110 may merge these duplicated generating chains and refine (e.g., reduce or minimize) the topological graph of RDD DAG, and thus, reduce system resource consumption, such as amount of used memory (e.g., local/remote volatile and/or non-volatile memory).

[0093] In some embodiments, the cache manager 110 differentiates between deterministic and non-deterministic operations and automatically tracks changes to the stored RDDs and their generating chains (e.g., time cost of re-computing if a cached RDD's parent RDD is evicted). However, not all functions can be uniquely determined by their signature/type and input. As such, according to some examples, the cache manager 110 operates only on deterministic functions, which may be determined uniquely (e.g., groupByKey, reduceByKey and sort can result in an identical hash or range partitioned RDD with the same input RDD(s)), and may not operate on non-deterministic functions, such as shuffling (or network traffic in general), which may output values in a non-deterministic manner.

[0094] FIG. 13 is a flow diagram illustrating the process 1110 of matching functions (i.e., the matchFunc function) performed by the cache manager 110, according to some example embodiments of the present invention.

[0095] In act 1300, the cache manager 110 first determines whether the two input functions are deterministic functions, which, for example, may be determined by searching through a list of preset deterministic functions (such as those listed in Table 3). If both input functions are deterministic, in act 1302, the cache manager 110 then compares the two functions to determine whether they are of the same type (i.e., signature) or not. In act 1302, the cache manager 110 returns the result of this comparison. If either of these two functions is not a deterministic function, the cache manager 110 returns False in act 1304. The process 1110 is also shown in pseudo code below:

Process 1110	
1	Procedure matchFunc (func ₁ ,func ₂)
2	if isDeterministicFunc(func ₁) and isDeterministicFunc(func ₂) then
3	return sameTypeFunc(func ₁ ,func ₂)
4	else
5	return False

[0096] FIG. 14 is a flow diagram illustrating the process 1012 of obtaining the longest reusable chain (i.e., the genRDDFrom function) performed by the cache manager 110, according to some example embodiments of the present invention.

[0097] In act 1400 to 1406, the cache manager 110 computes the longest reusable RDD generation logic chain (GenChain) by calling runTransformation from the longest reusable generating logic chain, following the new RDD is remaining generation logic chain. The process 1012 is also shown in pseudo code below:

Process 1012	
1	Procedure genRDDFrom (r _M ,r)
2	currR = r _M
3	for i ∈ [r.getGenChain() - r _M .getGenChain() , r.getGenChain()] do
4	currR = runFunction(r.func[i],currR)
5	return currR

[0098] It will be understood by a person of ordinary skill in the art that the flow diagrams and the pseudo-code presented above are only for illustrating the concepts of the present invention, and that the processes described may be modified in a suitable manner to be performed more efficiently using more advanced approaches. For example, in process 512, dynamic programming may be adopted to avoid updating those r_ps that will be evicted later (i.e., $r_p ∈ V ∩ R$).

[0099] It will be understood that, although the terms “first,” “second,” “third,” etc., may be used herein to describe various elements, components, regions, layers, and/or sections, these elements, components, regions, layers, and/or sections should not be limited by these terms. These terms are used to distinguish one element, component, region, layer, or section from another element, component, region, layer or section. Thus, a first element, component, region, layer, or section described herein could be termed a second element, component, region, layer, or section, without departing from the spirit and scope of the present invention.

[0100] The terminology used herein is for the purpose of describing particular embodiments only and is not intended to be limiting of the present invention. As used herein, the singular forms “a” and “an” are intended to include the plural forms as well, unless the context clearly indicates otherwise. It will be further understood that the terms “comprises,” “comprising,” “includes,” and “including,” when used in this specification, specify the presence of the stated features, integers, steps, operations, elements, and/or

components, but do not preclude the presence or addition of one or more other features, integers, steps, operations, elements, components, and/or groups thereof. As used herein, the term “and/or” includes any and all combinations of one or more of the associated listed items. Expressions such as “at least one of,” when preceding a list of elements, modify the entire list of elements and do not modify the individual elements of the list.

[0101] As used herein, the term “substantially,” “about,” and similar terms are used as terms of approximation and not as terms of degree, and are intended to account for the inherent variations in measured or calculated values that would be recognized by those of ordinary skill in the art. Further, the use of “may” when describing embodiments of the present invention refers to “one or more embodiments of the present invention.” As used herein, the terms “use,” “using,” and “used” may be considered synonymous with the terms “utilize,” “utilizing,” and “utilized,” respectively. Also, the term “exemplary” is intended to refer to an example or illustration.

[0102] When a certain embodiment may be implemented differently, a specific process order may be performed differently from the described order. For example, two consecutively described processes may be performed substantially at the same time or performed in an order opposite to the described order.

[0103] The electronic or electric devices and/or any other relevant devices or components according to embodiments of the present invention described herein may be implemented utilizing any suitable hardware, firmware (e.g., an application-specific integrated circuit), software, or a combination of software, firmware, and hardware. For example, the various components of these devices may be formed on one integrated circuit (IC) chip or on separate IC chips. Further, the various components of these devices may be implemented on a flexible printed circuit film, a tape carrier package (TCP), a printed circuit board (PCB), or formed on one substrate. Further, the various components of these devices may be a process or thread, running on one or more processors, in one or more computing devices, executing computer program instructions and interacting with other system components for performing the various functionalities described herein. The computer program instructions are stored in a memory which may be implemented in a computing device using a standard memory device, such as, for example, a random access memory (RAM). The computer program instructions may also be stored in other non-transitory computer readable media such as, for example, a CD-ROM, flash drive, or the like. Also, a person of skill in the art should recognize that the functionality of various computing devices may be combined or integrated into a single computing device, or the functionality of a particular computing device may be distributed across one or more other computing devices without departing from the spirit and scope of the exemplary embodiments of the present invention.

[0104] Unless otherwise defined, all terms (including technical and scientific terms) used herein have the same meaning as would be commonly understood by one of ordinary skill in the art to which the present invention belongs. It will be further understood that terms, such as those defined in commonly used dictionaries, should be interpreted as having meanings that are consistent with their meanings in the context of the relevant art and/or the present specification,

and should not be interpreted in an idealized or overly formal sense, unless expressly so defined herein.

[0105] While this invention has been described in detail with particular references to illustrative embodiments thereof, the embodiments described herein are not intended to be exhaustive or to limit the scope of the invention to the exact forms disclosed. Persons skilled in the art and technology to which this invention pertains will appreciate that alterations and changes in the described structures and methods of assembly and operation can be practiced without meaningfully departing from the principles, spirit, and scope of this invention, as set forth in the following claims and equivalents thereof.

What is claimed is:

1. A cache management system for managing a plurality of intermediate data, the cache management system comprising:

- a processor; and
- a memory having stored thereon the plurality of intermediate data and instructions that when executed by the processor, cause the processor to perform:
 - identifying a new intermediate data to be accessed;
 - loading the intermediate data from the memory in response to identifying the new intermediate data as one of the plurality of intermediate data; and
 - in response to not identifying the new intermediate data as one of the plurality of intermediate data:
 - identifying a reusable intermediate data having a longest duplicate generating logic chain that is at least in part the same as a generating logic chain of the new intermediate data; and
 - generating the new intermediate data from the reusable intermediate data and a portion of the generating logic chain of the new intermediate data not in common with the reusable intermediate data.

2. The cache management system of claim 1, wherein the instructions further cause the processor to perform:

- in response to a lack of sufficient space within the memory to store the new intermediate data:
 - selecting a set of victim intermediate data from the plurality of intermediate data to evict from the memory; and
 - evicting the set of victim intermediate data from the memory.

3. The cache management system of claim 1, wherein the identifying of the reusable intermediate data comprises:

- identifying a subset of intermediate data, each one of the subset of intermediate data having a same intermediate data source as the new intermediate data and a generating logic chain that is not longer than that of the new intermediate data; and
- comparing functions of the generating logic chain of each one of the subset of intermediate data to those of the new intermediate data, in a sequence, to identify the reusable intermediate data as one of the subset of intermediate data having a longest sequence of matching functions with the new intermediate data.

4. The cache management system of claim 3, wherein the sequence is an order of functions from the intermediate data source to the each one of the subset of intermediate data.

5. The cache management system of claim 3, wherein the intermediate data source of each of the subset of intermediate data has a same size as, and a same type as, that of the new intermediate data.

6. The cache management system of claim 3, wherein the identifying of the subset of intermediate data comprises:

comparing, byte-to-byte, the intermediate data source of each one of the subset of intermediate data with the new intermediate data.

7. The cache management system of claim 3, wherein the comparing of the functions of the generating logic chain of each one of the subset of intermediate data to those of the new intermediate data comprises:

determining that the functions of the generating logic chain of each one of the subset of intermediate data and those of the new intermediate data are deterministic; and

in response, determining that types of the functions of the generating logic chain of each one of the subset of intermediate data are the same as those of the new intermediate data.

8. The cache management system of claim 7, wherein the determining that the functions are deterministic comprises:

matching each of the functions with one of a preset list of deterministic functions.

9. The cache management system of claim 1, wherein the generating of the new intermediate data from the reusable intermediate data comprises:

successively applying, to the reusable intermediate data, functions of the generating logic chain of the new intermediate data not in common with the reusable intermediate data to generate the new intermediate data.

10. The cache management system of claim 1, wherein each one of the plurality of intermediate data is a resilient distributed data (RDD), and

wherein the cache management system operates under a Spark framework.

11. A method of managing a plurality of intermediate data stored in memory, the method comprising:

identifying, by a processor, a new intermediate data to be accessed;

loading, by the processor, the intermediate data from the memory in response to identifying the new intermediate data as one of the plurality of intermediate data; and in response to not identifying the new intermediate data as one of the plurality of intermediate data:

identifying, by the processor, a reusable intermediate data having a longest duplicate generating logic chain that is at least in part the same as a generating logic chain of the new intermediate data; and

generating, by the processor, the new intermediate data from the reusable intermediate data and a portion of the generating logic chain of the new intermediate data not in common with the reusable intermediate data.

12. The method of claim 11, further comprising:

in response to a lack of sufficient space within the memory to store the new intermediate data:

selecting, by the processor, a set of victim intermediate data from the plurality of intermediate data to evict from the memory; and

evicting, by the processor, the set of victim intermediate data from the memory.

13. The method of claim 11, wherein the identifying of the reusable intermediate data comprises:

identifying, by the processor, a subset of intermediate data, each one of the subset of intermediate data having a same intermediate data source as the new intermediate data and a generating logic chain that is not longer than that of the new intermediate data; and

comparing, by the processor, functions of the generating logic chain of each one of the subset of intermediate data to those of the new intermediate data, in a sequence, to identify the reusable intermediate data as one of the subset of intermediate data having a longest sequence of matching functions with the new intermediate data.

14. The method of claim 13, wherein the sequence is an order of functions from the intermediate data source to the each one of the subset of intermediate data.

15. The method of claim 13, wherein the intermediate data source of each of the subset of intermediate data has a same size as, and a same type as, that of the new intermediate data.

16. The method of claim 13, wherein the identifying of the subset of intermediate data comprises:

comparing, byte-to-byte, by the processor, the intermediate data source of each one of the subset of intermediate data with the new intermediate data.

17. The method of claim 13, wherein the comparing of the functions of the generating logic chain of each one of the subset of intermediate data to those of the new intermediate data comprises:

determining, by the processor, that the functions of the generating logic chain of each one of the subset of intermediate data and those of the new intermediate data are deterministic; and

in response, determining, by the processor, that types of the functions of the generating logic chain of each one of the subset of intermediate data are the same as those of the new intermediate data.

18. The method of claim 17, wherein the determining that the functions are deterministic comprises:

matching, by the processor, each of the functions with one of a preset list of deterministic functions.

19. The method of claim 11, wherein the generating of the new intermediate data from the reusable intermediate data comprises:

successively applying, to the reusable intermediate data, by the processor, functions of the generating logic chain of the new intermediate data not in common with the reusable intermediate data to generate the new intermediate data.

20. The method of claim 11, wherein each one of the plurality of intermediate data is a resilient distributed data (RDD) within a Spark framework.

* * * * *